



## Series 4C, 8C and 16C Microprocessor Based Temperature Process Control

Specifications - Installation and Operating Instructions



**LOVE CONTROLS DIVISION  
DWYER INSTRUMENTS INC.**

P.O. BOX 338 - MICHIGAN CITY, INDIANA 46361, U.S.A.

Phone: 219/879-8000 [www.love-controls.com](http://www.love-controls.com)

Fax: 219/872-9057 e-mail:[love@love-controls.com](mailto:love@love-controls.com)

**TABLE OF CONTENTS**

Model Number Identification . . . . . 3

Getting Started . . . . . 3

Installation . . . . . 4

Panel Cutout Dimensions . . . . . 4

Mounting . . . . . 5

Wiring Diagrams . . . . . 6

Front Panel Key Functions . . . . . 7

Security Features . . . . . 7

Control Operation Description . . . . . 8

Programming and Operation for PID Function . . . . . 9

Description of Menu Structure . . . . . 10

Operation Menu . . . . . 10

Regulation Menu . . . . . 11-12

Initial Setting Menu . . . . . 13-14

Alarm Output Description . . . . . 15

Communication Register List . . . . . 16

Communication Protocol . . . . . 17

Diagnostic Error Messages . . . . . 18

Reset Factory Default Setting . . . . . 19

Specifications . . . . . 20

Input Sensor Ranges . . . . . 21

Precautions . . . . . 22

External Dimensions . . . . . 23

## MODEL NUMBER IDENTIFICATION

**4C** — 

**OUTPUT 1** — 

- 2 = Voltage Pulse
- 3 = Relay
- 5 = Current
- 6 = Linear Voltage

**8C** — 

**OUTPUT 1** — 

- 2 = Voltage Pulse
- 3 = Relay
- 5 = Current
- 6 = Linear Voltage

**16C** — 

**OUTPUT 1** — 

- 2 = Voltage Pulse
- 3 = Relay
- 5 = Current
- 6 = Linear Voltage

## GETTING STARTED

1. Install the control as described on page 4.
2. Wire your control following the instructions on page 6. Please read the Precautions section located at the end of this manual before wiring the control.
3. For best results when programming changes are necessary, make all changes to the Initial Setting mode (Pages 13-14) before making changes to the Regulation Mode (Pages 11-12) or Operation Mode (Pages 10). If any error messages occur, check the Diagnostic Error Message Section (Page 18) for assistance.

## INSTALLATION

Mount the instrument in a location that will not be subject to excessive temperature, shock, or vibration. All models are designed for mounting in an enclosed panel.

Select the position desired for the instrument on the panel. Prepare the panel by cutting and deburring the required opening per the panel cut out dimensions listed below. Follow the mounting instructions listed on page 5. Lastly, wire the controller per the appropriate wiring diagram listed on page 6.

## PANEL CUTOUT DIMENSIONS

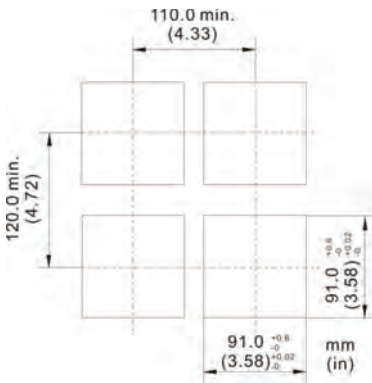

4C

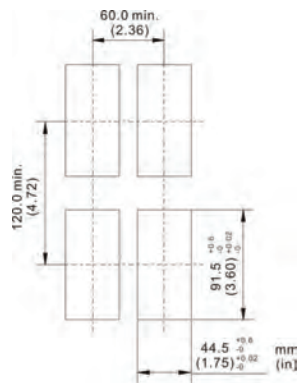

8C

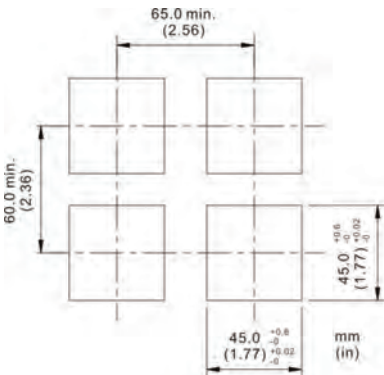

16C

## MOUNTING METHOD

- Step 1: From the front of the panel, slide the controller housing through the cut out. The housing gasket should be against the housing flange before installing.
- Step 2: Insert the mounting brackets into the mounting grooves on the top and bottom of the controller (4C, 8C, and 16C).
- Step 3: Push the mounting brackets forward until the bracket stops at the panel wall.
- Step 4: Insert and tighten the screws on the bracket to secure the controller in place. (The screw torque should be 0.8 kgf-cm).

## Mounting Bracket Installation

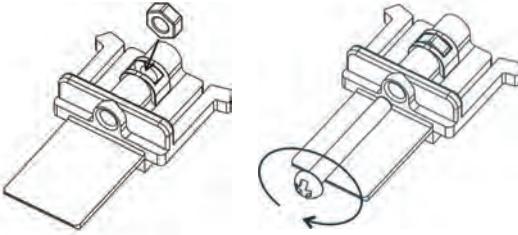

## 4C/8C/16C Mounting Method

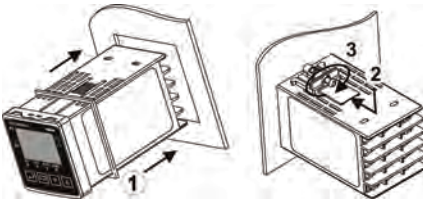

## WIRING

Do not run thermocouple or other class 2 wiring in the same conduit as power leads. Use only the type of thermocouple or RTD probe for which the control has been programmed. Maintain separation between wiring of sensor, auxiliary in or out, and other wiring. See the Initial Setting Menu for input selection.

For thermocouple input always use extension leads of the same type designated for your thermocouple.

For supply connections use No. 16 AWG or larger wires rated for at least 75° C. Use conductors only. All line voltage output circuits must have a common disconnect and be connected to the same pole of the disconnect.

Input wiring for thermocouple, current, and RTD; and output wiring for current 14 VDC is rated CLASS 2.

Control wiring as show below:

### Terminal Identification

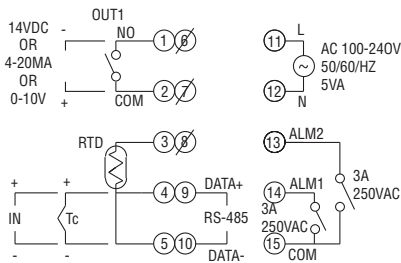
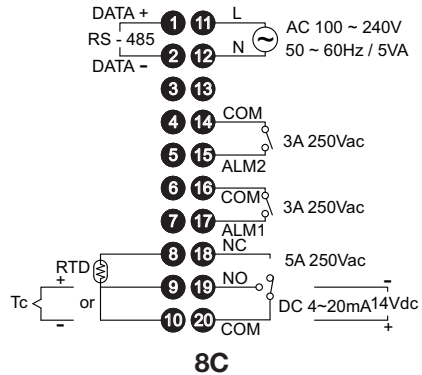
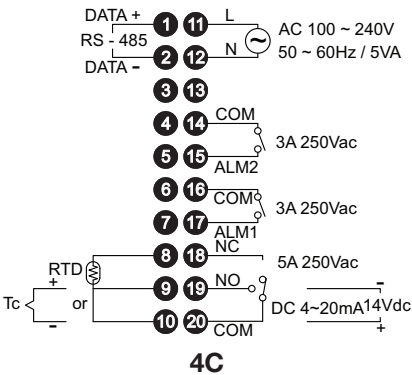

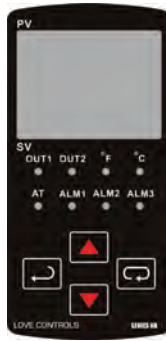

## FRONT KEY FUNCTIONS

Key functions are as follows:



**INDEX:** Pressing the INDEX key advances the display to the next menu item.



**UP ARROW:** Increments a value or changes a menu item. If pressed during the Operation Mode, the set point value will be increased.



**DOWN ARROW:** Decrements a value or changes a menu item. If pressed during the **Operation Mode**, the set point value will be decreased.



**ENTER:** Stores the value or item change. If not pressed, the previously stored value or item will be retained. When pressed during the **Operation Mode**, the controller switches to the **Regulation Mode**. If held for more than 3 seconds during the **Operation Mode**, the controller switches to the **Initial Setting Mode**. If pressed during the **Regulation Mode** or **Initial Setting Mode**, the controller will return to the **Operation Mode**.

## SECURITY FEATURES

The C series controller has two built in security lock settings to prevent unauthorized personnel from changing parameter settings. These parameters are set in the **Operation Mode**.

The LoC1 setting affects all parameters in the controller. If LoC1 setting is enabled, the operator will have to unlock the controller to make any changes to the controller's parameters.

The LoC2 setting affects all parameters except the set point. If LoC2 setting is enabled, the only parameter that the operator will be able to change is the set point. In order to change any other parameters, the operator will have to unlock the control before making a change.

In order to unlock the control, the operator must depress the ENTER and INDEX key simultaneously.

## **CONTROL OPERATION DESCRIPTION**

The HOME display is the normal display while the control is operating. If no errors or functions are active, the HOME display will indicate the Process Variable that is being measured on the top display and the Set Variable on the bottom display.

Error Messages are shown on page 18.

### **Heating or Cooling**

Temperature Control can be achieved by either heating or cooling. Please refer to the following for the operation of each setting.

Control Modes are selected by changing the S-HC parameter in the Initial Setting Mode.

Select HEAt, for heating or reverse acting control for output 1.

Select CoolL, for cooling or direct acting control for output 1.



## **PROGRAMMING AND OPERATION FOR PID**

### **Theory of Operation**

The PID method of control is based on the individual tuning of proportional band values, integral time values, and derivative time values to help a unit automatically compensate for changes in a control system. The proportional band is the range around the set point in which the control's proportioning takes place. The control increases or decreases the output proportionately to the process temperature's deviation from the set point. The integral time eliminates undershoot and overshoot of the set point by adjusting the proportioning control based on the amount of deviation from the set point during steady state operation. The derivative time eliminates undershoot and overshoot by adjusting the proportioning control based on the rate of rise or fall of the process temperature. The integral deviation offset correction (ioFn) improves the speed in which the process value reaches the set point value. If this parameter is set to zero, the output will be zero when the process value is equal to the set point value. If the integral time parameter is used only to eliminate steady state error, it may take a long time to reach the set point because it needs time to accumulate the error. This parameter defines the default output level on start up. When the integral time is set at 0, then the proportional derivative offset correction (PdoF) would replace the integral deviation offset correction, but serves the same function.

### **Program Set Up**

In order to use the PID function in the C series controllers, the Control Mode will have to be set to PID in the Initial Setting Menu. After changing the Control Mode, the PID parameters can be accessed in the Regulation Menu. The PID parameters can either be programmed manually or they can be set by the controller using the auto tune function. The auto tune will use trial and error to tune the PID parameters to give the control the most precise control. Since the time to accurately tune the control may differ depending on the process, the controller can also be manually tuned to known PID values prior to running auto tune. The Run/Stop parameter must be set to run in order to start auto tuning.

## DESCRIPTION OF MENU STRUCTURE

The programming for the controller is broken down into three menus (Operation, Regulation, and Initial Setting). Upon normal operation, control will be in the Operation Menu.

### OPERATION MENU

Pressing the INDEX key will cycle through the below menu items. The parameter will be displayed in the top display, while its value will be displayed in the bottom display, except for the set point which is displayed in the bottom display on the Home Display. The UP and DOWN arrows change the values of the parameters. The ENTER key must be pressed after any changes.

<i>1234</i>		Adjust the set point value - Can be any numerical value between the upper and lower limit of the temperature range.
<i>r-S</i>		Select Run - Stop Output Control.
	<i>rUn</i> <i>StoP</i>	Activates outputs. De-activates outputs.
<i>AL 1H</i>		Alarm 1 High Set Point. May not appear depending on ALA1 setting in Initial Setting Menu.
<i>AL 1L</i>		Alarm 1 Low Set Point. May not appear depending on ALA1 setting in Initial Setting Menu.
<i>AL2H</i>		Alarm 2 High Set Point. May not appear depending on ALA2 setting in Initial Setting Menu.
<i>AL2L</i>		Alarm 2 Low Set Point. May not appear depending on ALA2 setting in Initial Setting Menu.
<i>LoC</i>		Set front panel security lock.
	<i>LOC 1</i> <i>LOC 2</i>	Lock all settings. Lock all settings except the set point.
<i>out 1</i>		Display the % output value for output 1. In manual mode, this value can be changed using the up and down arrows.

## REGULATION MENU

Press the ENTER key while at the Home Display in order to access the Regulation Menu. Pressing the INDEX key will cycle through the below menu items. The parameter will be displayed in the top display, while its value will be displayed in the bottom display. The UP and DOWN arrows change the values of the parameters. The ENTER key must be pressed after any changes.

<i>At</i>	Auto Tune. The controller will evaluate the process and select the PID values to maintain good control. Only available when the control mode is set to PID.
<i>on</i>	Start learning the process. After the process has been learned the menu will revert to oFF.
<i>oFF</i>	Disables Auto Tune.
<i>P</i>	Proportional Band Setting.
<i>i</i>	Integral time (reset time).
<i>d</i>	Derivative time (rate time).
<i>PdoF</i>	PD Offset Correction Setting. only available when control mode is set to PID and integral time = 0. See Programming and Operation of PID function for moving information.
<i>ioFn</i>	Integral Deviation Offset Correction associated with each PID Profile. (n = 0 to 4).
<i>HtS</i>	Heating Hysteresis (Differential) Setting. Sets the value for the amount of difference between the turn off point (set point) and the turn on point. Figure A shows the output behavior for a heating (reverse acting) application. Only available when control mode set to on/off control.
<i>CtS</i>	Cooling Hysteresis (Differential) Setting. Sets the value for the amount of difference between the turn off point (set point) and the turn on point. Figure A shows the output behavior for a cooling (direct acting) application. Only available when control mode set to on/off control.

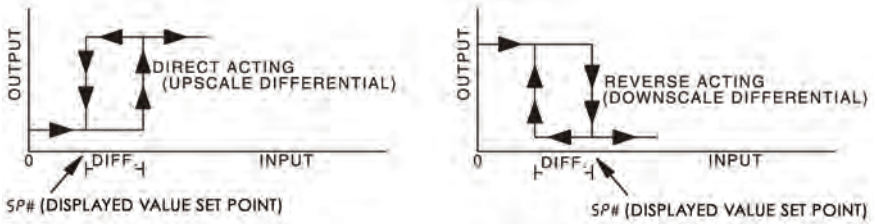

Figure A: Output behavior for Heating/Cooling On/Off Applications

*HtPd*

Heating Control Cycle Setting. Defines the duration for one output period or cycle for output 1. Only available when control mode is set to PID and Output 1 is set for heating.

*CLPd*

Cooling Control Cycle Setting. Defines the duration for one output period or cycle for output 1. Only available when control mode is set to PID and Output 1 is set for cooling.

*tPof*

Process Temperature Offset. This feature allows the input value to be changed to agree with an external reference or to compensate for sensor error.

*Crh*

Analog Output High Limit: Sets the actual upper limit of the analog output when the control's output is operating at 100%. Only available for analog output models.

*CrLo*

Analog Output Low Limit. Sets the actual lower limit of the analog output when the control's output is operating at 0%. Only available for analog output models.

## INITIAL SETTING MENU

Press and hold the ENTER key for at least 3 seconds while at the Home Display in order to access the Initial Setting Menu. Pressing the INDEX key will cycle through the below menu items. The parameter will be displayed in the top display, while its value will be displayed in the bottom display. The UP and DOWN arrows change the values of the parameters. The ENTER key must be pressed after any changes.

**Input Selection**

Input Selection. Select one of the following input types from the below table.

Input Temperature Sensor Type	LED Display	Temperature Range
Thermocouple TXK type	TXK	-328 ~ 1440°F (-200 ~ 800°C)
Thermocouple U type	U	-328 ~ 932°F (-200 ~ 500°C)
Thermocouple L type	L	-328 ~ 1562°F (-200 ~ 850°C)
Thermocouple B type	b	212 ~ 3272°F (100 ~ 1800°C)
Thermocouple S type	S	32 ~ 3092°F (0 ~ 1700°C)
Thermocouple R type	r	32 ~ 3092°F (0 ~ 1700°C)
Thermocouple N type	n	-328 ~ 2340°F (-200 ~ 1300°C)
Thermocouple E type	E	32 ~ 1112°F (0 ~ 600°C)
Thermocouple T type2	T2	-4 ~ 752°F (-20 ~ 400°C)
Thermocouple T type1	T1	-328 ~ 752°F (-200 ~ 400°C)
Thermocouple J type2	J2	-4 ~ 752°F (-20 ~ 400°C)
Thermocouple J type1	J1	-148 ~ 1562°F (-100 ~ 850°C)
Thermocouple K type2	K2	-4 ~ 932°F (-20 ~ 500°C)
Thermocouple K type1	K1	-328 ~ 2340°F (-200 ~ 1300°C)
Platinum Resistance (Pt100) type 3	Pt3	32 ~ 212°F (0 ~ 100°C)
Platinum Resistance (Pt100) type 2	Pt2	-4 ~ 932°F (-20 ~ 500°C)
Platinum Resistance (Pt100) type 1	Pt1	-328 ~ 1112°F (-200 ~ 600°C)
Platinum Resistance (JPt100) type 2	JPt2	32 ~ 212°F (0 ~ 100°C)
Platinum Resistance (JPt100) type 1	JPt1	-4 ~ 752°F (-20 ~ 400°C)

**Temperature Units**

Temperature Units. This parameter is only available for thermocouple or RTD inputs.

**Scale Height Limit**

Scale Height Limit. Sets the upper limit of the temperature range. If the process temperature exceeds this setting, the display will flash an error code.

**Scale Low Limit**

Scale Low Limit. Sets the lower limit of the temperature range. If the process temperature exceeds this setting, the display will flash an error code.

**Control Mode**

Control Mode. Select method of control operation. Can be set to PID, On-Off, or Manual.

<i>S-HC</i>	Heat/Cool Selection. Assigns output 1 to be either heat or cool.  HEAt = Output 1 = Heating Cool = Output 1 = Cooling
<i>ALA1</i>	Alarm 1 Setting. Sets operation for Alarm 1. Please see selection on Alarm Outputs for description of the outputs.
<i>ALA2</i>	Alarm 2 Setting. Sets operation for Alarm 2. Please see selection on Alarm Outputs for description of the outputs.
<i>CoSH</i>	Communications Write Function Feature. Allows parameters to be changed via the RS-485 communications. Setting to OFF prevents any changes from remote users.
<i>C-no</i>	Controller Address: Set from 1 to 247. This value must match the controller address used by the host computer.
<i>bPS</i>	Baud Rate Setting. This value must match the communication baud rate of the host computer.
<i>LEn</i>	Communication Data Length. Choose either 7 or 8. This value must match the communication data length of the host computer.
<i>PrtY</i>	Communication Parity Bit. Set this value to even, odd, or none. This value must match the communication parity bit of the host computer.
<i>StoP</i>	Communication Stop Bit. Set this value to 1 or 2. This value must match the communication stop bit of the host computer.

## Alarm Output Configuration and Operation Table.

Set Value	Alarm Type	Alarm Output Operation
0	Alarm function disabled	Output is OFF
1	Deviation upper- and lower-limit: This alarm output operates when PV value is higher than the setting value SV+(AL-H) or lower than the setting value SV-(AL-L).	
2	Deviation upper-limit: This alarm output operates when PV value is higher than the setting value SV+(AL-H).	
3	Deviation lower-limit: This alarm output operates when PV value is lower than the setting value SV-(AL-L).	
4	Reverse deviation upper- and lower-limit: This alarm output operates when PV value is in the range of the setting value SV+(AL-H) and the setting value SV-(AL-L).	
5	Absolute value upper- and lower-limit: This alarm output operates when PV value is higher than the setting value AL-H or lower than the setting value AL-L.	
6	Absolute value upper-limit: This alarm output operates when PV value is higher than the setting value AL-H.	
7	Absolute value lower-limit: This alarm output operates when PV value is lower than the setting value AL-L.	
8	Deviation upper- and lower-limit with standby sequence: This alarm output operates when PV value reaches set point (SV value) and the value is higher than the setting value SV+(AL-H) or lower than the setting value SV-(AL-L).	
9	Deviation upper-limit with standby sequence: This alarm output operates when PV value reaches set point (SV value) and the reached value is higher than the setting value SV+(AL-H).	
10	Deviation lower-limit with standby sequence: This alarm output operates when PV value reaches the set point (SV value) and the reached value is lower than the setting value SV-(AL-L).	
11	Hysteresis upper-limit alarm output: This alarm output operates if PV value is higher than the setting value SV+(AL-H). This alarm output is OFF when PV value is lower than the setting value SV+(AL-L).	
12	Hysteresis lower-limit alarm output: This alarm output operates if PV value is lower than the setting value SV-(AL-H). This alarm output is OFF when PV value is higher than the setting value SV-(AL-L).	

(Note: AL-H and AL-L include AL1H, AL2H, AL3H and AL1L, AL2L, AL3L)

## Communication Register List

### Communication Parameters List

Controller offers a RS-485 port for serial communication.

1. Supporting transmission speed: 2400, 4800, 9600, 19200, 38400 bps.
2. Communication protocol: Modbus (ASCII).
3. Non-supported formats: 7, N, 1 or 8, O, 2 or 8, E, 2.
4. Available communication address: 1 to 255, 0 is broadcast address.
5. Function code: 03H to read the contents of register (Max. 3 words).
6. 06H to write 1 (one) word into register.

Address	Content	Explanation
4700H (R)	Process value (PV)	Measuring unit is 0.1, updated one time in 0.5 second.
4701H	Set point (SV)	Unit is 0.1, oC or oF
4702H	Upper-limit alarm 1	
4703H	Lower-limit alarm 1	
4704H	Upper-limit alarm 2	
4705H	Lower-limit alarm 2	
4706H	Upper-limit of temperature range	The data content should not be higher than the temperature range
4707H	Lower-limit of temperature range	The data content should not be lower than the temperature range
4708H	PB Proportional band	0.1 to 999.9, unit is 0.1
4709H	Ti Integral time	0 to 9999
470AH	Td Derivative time	0 to 9999
470BH	Heating/Cooling hysteresis	0 to 9999
470CH ~ 470FH		Reserved
4710H	Input temperature sensor type	Please refer to the contents of the "Temperature Sensor Type and Temperature Range" for detail
4711H	Control method	0: PID (default), 1: ON/OFF, 2: manual tuning
4712H	Heating/Cooling control cycle	1 to 99 second
4713H	Proportional control offset error value	0% to 100%
4714H	Temperature regulation value	-999 ~ 999, unit: 0.1
4715H	Alarm 1 type	Please refer to the contents of the "Alarm Outputs" for detail
4716H	Alarm 2 type	Please refer to the contents of the "Alarm Outputs" for detail
4717H	Temperature unit display selection	oC: 1 (default), oF: 0
4718H	Heating/Cooling control Selection	Heating: 0 (default), Cooling: 1
4719H	Control Run/Stop setting	Run: 1 (default), Stop: 0
471AH	Communication write-in selection	Communication write in disabled: 0 (default), Communication write in enabled: 1
471BH	Software version	W1.00 indicates 0 x 100
4729H	AT Setting	OFF: 0 (default), ON:1
472BH (R)	Code 0	Normal operation (No error)
	Code 1	Initial process
	Code 2	Initial status (Temperature is not stable)
	Code 3	Temperature sensor is not connected
	Code 4	Temperature sensor input error
	Code 5	Measured temperature value exceeds the temperature range
	Code 6	No Int. error
	Code 7	EEPROM Error
4733H	CT monitor value	Unit is 0.1A

Note: R means "read only" value



## Communication Protocol

Command code to read N words: 03H. The maximum value of N is 3.

For example, in order to read two words from controller 01 (address 01H) at starting data address 4700H, the command in ASCII mode is:

ASCII mode:

Command message:

Response message:

STX	':'
ADR1	'0'
ADR0	'1'
CMD1	'0'
CMD0	'3'
Starting data address	'4'
	'7'
	'0'
	'0'
Number of data (count by word)	'0'
	'0'
	'2'
LRC CHK 1	'B'
LRC CHK 0	'3'
END 1	CR
END 0	LF

STX	':'
ADR1	'0'
ADR0	'1'
CMD1	'0'
CMD0	'3'
Number of data (count by byte)	'0'
	'4'
Content of start address 4700H	'0'
	'1'
	'9'
	'0'
Content of start address 4700H	'0'
	'0'
	'0'
LRC CHK 1	'6'
LRC CHK 0	'7'
END 1	CR
END 0	LF

LRC check:

LRC check is the added sum from "Address" to Data content". For example, 01H + 03H + 47H + 00H + 00H + 02H = 4DH, then take the complementary of 2, B3H.

Command code to write 1 word: 06H

For example, in order to write 1000 (03E8H) in controller 01 (comm. address 01H) at starting data address 4701H, the command in ASCII mode is:

ASCII mode:

Command message:

Response message:

STX	':'
ADR1	'0'
ADR0	'1'
CMD1	'0'
CMD0	'6'
Starting data address	'4'
	'7'
	'0'
	'1'
Data Content	'0'
	'3'
	'E'
	'8'
LRC CHK 1	'C'
LRC CHK 0	'6'
END 1	CR
END 0	LF

STX	':'
ADR1	'0'
ADR0	'1'
CMD1	'0'
CMD0	'6'
Starting data addresses	'4'
	'7'
	'0'
	'1'
Data Content	'0'
	'3'
	'E'
	'8'
LRC CHK 1	'C'
LRC CHK 0	'6'
END 1	CR
END 0	LF

## DIAGNOSTIC ERROR MESSAGES

### Display Error Messages

Display		Description	Action Required
PV	b150	Display on Start Up	No Action Required
SV	rr		
PV	No	No Input Probe Connection	Verify that sensor is wired to proper terminals. Next, check that the controller is programmed for the correct input type. Most commonly seen when controller is programmed for a RTD, while a thermocouple is connected.
SV	Cont		
PV	Err	Input Error	Verify that the input is wired to the proper terminals. Next check to see if the input type is set to the proper value. Most commonly seen when controller is programmed for a 4 to 20 mA input and 0 to 20 mA signal is wired to the controller.
SV	inPt		
PV	2001	Process Value Flashes when outside of range	Input signals may normally go above or below range limits. If not check input and correct the process temperature or increase temperature range limits using tP-H and tP-L.
SV	0.0		
PV	Err	Error EEPROM	Attempt to reset the factory default settings using the instructions in the next section. If still has error, call customer service for a return goods authorization number to have the controller evaluated at the factory.
SV	Pron		

### Communication Error Messages

Error Status 102EH/4750H	PV read back 1000H/4700H	Error Status
0001H	N/A	PV Unstable
0002H	8002H	Re-initialize, no temperature at this time
0003H	8003H	Input sensor did not connect
0004H	8004H	Input Signal Error
0005H	N/A	Over Input Range
0006H	8006H	ADC fail
0007H	N/A	EEPROM read/write error

## **Reset Factory Default Settings**

Note: Resetting Factory Default Settings erases all of the values entered by the user. Record any necessary settings before proceeding.

Warning: Erasing the user entered values may result in a safety hazard and system malfunction.

The following instructions will reset the controller to the original factory default settings.

- Step 1. Press the INDEX KEY while at the Home Display until the controller reads LoC in the process display. Use the UP arrow to select LoC1. Press the ENTER KEY to save this value.
- Step 2. Press and hold the UP and DOWN arrows simultaneously for one second. Upon releasing the buttons, the display will read SHou in the PV display and OFF in the SV display.
- Step 3. Press the INDEX key once and the controller will read PASS in the PV display and a 4321 in the SV display. Adjust the value in the SV display to 1357 using the UP and DOWN arrows. Press the ENTER KEY to save the value.
- Step 4. Cycle the power on the controller. Upon power up, all of the user set values have been erased.

## SPECIFICATIONS

<b>Input Voltage</b>	100 to 240VAC 50/60Hz.
<b>Operation Voltage Range</b>	85% to 110% of rated voltage.
<b>Power Consumption</b>	5VA max.
<b>Memory Protection</b>	EEPROM 4K bit (non-volatile memory (number of writes: 100,000).
<b>Display Method</b>	2 line x 4 character 7-segment LED display. Process value (PV): Red color, Set point (SV): Green color.
<b>Sensor Type</b>	Thermocouple: K, J, T, E, N, R, S, B, L, U, TXK. 3-wire Platinum RTD: Pt100, JPt100.
<b>Control Mode</b>	PID, ON/OFF, or Manual.
<b>Control Output</b>	Relay output: SPDT (SPST: 1/16 DIN). Max.600. Voltage pulse output: DC 14V, Max. output current 40mA. Current output: DC 4 ~ 20mA output (Load resistance: Max. 600Ω).
<b>Display Accuracy</b>	0.1% of measuring range.
<b>Sampling Range</b>	Thermocouple or Platinum RTD: 500 msec/per scan.
<b>RS-485 Communication</b>	MODBUS ASCII communication protocol
<b>Vibration Resistance</b>	10 to 55 Hz, 10 m/s <sup>2</sup> for 10 min, each in X, Y and Z direction.
<b>Shock Resistance</b>	Max. 300 m/s <sup>2</sup> , 3 times in each 3 axes, 6 directions
<b>Ambient Temperature</b>	32°F to 122°F (0°C to + 50°C)
<b>Storage Temperature</b>	-4°F to 150°F (-20°C + 65°C)
<b>Altitude</b>	2000 m or less
<b>Relative Humidity</b>	0% to 80% (non-condensing)

Thermocouple Type and Temperature Range		
Input Temperature Sensor Type	LED Display	Temperature Range
Thermocouple TXK type	$\text{tT}$	-328 ~ 1440°F (-200 ~ 800°C)
Thermocouple U type	$U$	-328 ~ 932°F (-200 ~ 500°C)
Thermocouple L type	$L$	-328 ~ 1562°F (-200 ~ 850°C)
Thermocouple B type	$b$	212 ~ 3272°F (100 ~ 1800°C)
Thermocouple S type	$S$	32 ~ 3092°F (0 ~ 1700°C)
Thermocouple R type	$r$	32 ~ 3092°F (0 ~ 1700°C)
Thermocouple N type	$n$	-328 ~ 2340°F (-200 ~ 1300°C)
Thermocouple E type	$E$	32 ~ 1112°F (0 ~ 600°C)
Thermocouple T type2	$t2$	-4 ~ 752°F (-20 ~ 400°C)
Thermocouple T type1	$t1$	-328 ~ 752°F (-200 ~ 400°C)
Thermocouple J type2	$J2$	-4 ~ 752°F (-20 ~ 400°C)
Thermocouple J type1	$J1$	-148 ~ 1562°F (-100 ~ 850°C)
Thermocouple K type2	$K2$	-4 ~ 932°F (-20 ~ 500°C)
Thermocouple K type1	$K1$	-328 ~ 2340°F (-200 ~ 1300°C)
RTD Type and Temperature Range		
Input Temperature Sensor Type	LED Display	Temperature Range
Platinum Resistance (Pt100) type 3	$Pt3$	32 ~ 212°F (0 ~ 100°C)
Platinum Resistance (Pt100) type 2	$Pt2$	-4 ~ 932°F (-20 ~ 500°C)
Platinum Resistance (Pt100) type 1	$Pt1$	-328 ~ 1112°F (-200 ~ 600°C)
Platinum Resistance (JPt100) type 2	$JPt2$	32 ~ 212°F (0 ~ 100°C)
Platinum Resistance (JPt100) type 1	$JPt1$	-4 ~ 752°F (-20 ~ 400°C)

## PRECAUTIONS



### **DANGER! Caution! Electric Shock!**

1. Do not touch the AC terminals while the power is supplied to the controller to prevent an electric shock.
2. Make sure power is disconnected while checking the unit inside.
3. The symbol  indicates that this Controller is protected throughout by DOUBLE INSULATION or REINFORCED INSULATION (equivalent to Class II of IEC 536).



### **WARNING!**

**Mount the controller in a location that will not be subject to excessive temperature, shock, or vibration. All models are designed for mounting in an enclosed panel.**

1. Always use recommended solder-less terminals: Fork terminals with isolation (M3 screw, width is 7.0mm (6.0mm for 32B Series), hole diameter 3.2mm). Screw size: M3 x 6.5 (With 6.8 x 6.8 square washer). Screw size for 32B Series: M3 x 4.5 (With 6.0 x 6.0 square washer). Recommended tightening torque: 0.4 N.m (4kgf.cm). Applicable wire: Solid/twisted wire of 2 mm<sup>2</sup>, 12AWG to 24AWG. Please be sure to tighten them properly.
2. Do not allow dust or foreign objects to fall inside the controller to prevent it from malfunctioning.
3. Never modify or disassemble the controller.
4. Do not connect anything to the "No used" terminals.
5. Make sure all wires are connected to the correct polarity of terminals.
6. Do not install and/or use the controller in places subject to: Dust or corrosive gases and liquid, high humidity and high radiation, vibration and shock, high voltage and high frequency.
7. Power must be off when wiring and changing a temperature sensor.
8. Be sure to use compensating wires that match the thermocouple types when extending or connecting the thermocouple wires.
9. Please use wires with resistance when extending or connecting a platinum resistance sensor (RTD).
10. Please keep the wire as short as possible when wiring a platinum resistance sensor (RTD) to the controller and please route power wires as far as possible from load wires to prevent interference and induce noise.
11. This controller is an open-type unit and must be placed in an enclosure away from high temperature, humidity, dripping water, corrosive materials, airborne dust and electric shock or vibration.
12. Please make sure power cables and signals from instruments are all installed properly before energizing the controller, otherwise serious damage may occur.
13. Please do not use acid or alkaline liquids for cleaning. Please use a soft, dry cloth to clean the controller.
14. Wait at least one minute after power is disconnected to allow capacitors to discharge, and please do not touch any internal circuit within this period.
15. This instrument is not furnished with a power switch or fuse. Therefore, if a fuse or power switch is required, install the protection close to the instrument. Recommended fuse rating: Rated voltage 250 V, Rated current 1 A. Fuse type: Time-lag fuse.
16. Note: This controller does not provide overcurrent protection. Use of the product requires that suitable overcurrent protection device(s) must be added to ensure compliance with all relevant electrical standards and codes. (Rated 250 V, 15 Amps max). A suitable disconnecting device should be provided near the controller in the end-use installation.

## External Dimensions

Dimensions are in millimeter (inch)

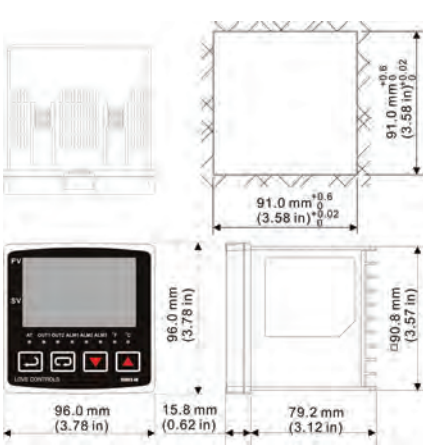

**4C**

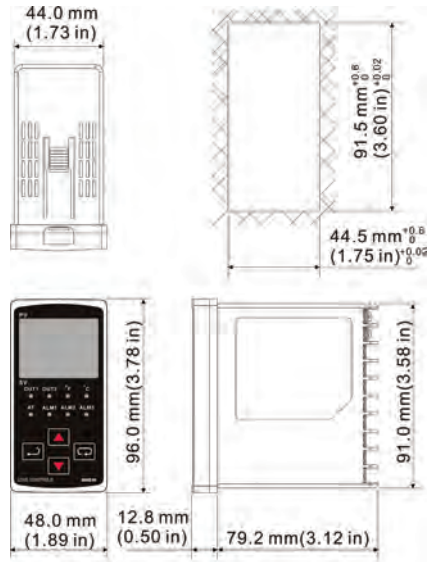

**8C**

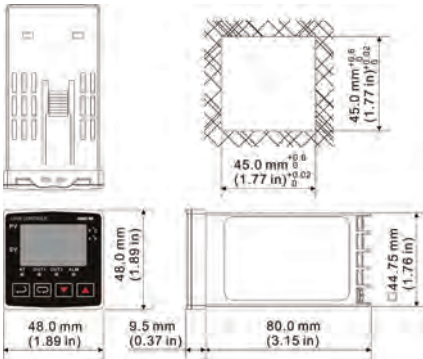

**16C**

**LOVE CONTROLS DIVISION  
DWYER INSTRUMENTS INC.**

P.O. BOX 338 - MICHIGAN CITY, INDIANA 46361, U.S.A.

Phone: 219/879-8000 [www.love-controls.com](http://www.love-controls.com)

Fax: 219/872-9057 e-mail:[love@love-controls.com](mailto:love@love-controls.com)