

VA 400 consumption sensor

Stationary and mobile
flow and consumption measurement
for compressed air and gases

Optionen:

VA 400 with display*

VA 400 - Max.

VA 400 - HighSpeed

* Operation menu for the display with capacitive key buttons



	Page
Important information before initiation	3
Safety instructions	4-5
Technical data	6
Instruments description	7
Installation description	7-8
Assembly instructions	9
Measuring ranges VA 400 - Standard	10-11
Measuring ranges VA 400 - Max.	12-13
Measuring ranges VA 400 - HighSpeed	14-15
Max. velocities of the different gases	16
Drawing/Dimensions of the instrument / Pulse output	17
Pulse output signals / pulse lengths	18
Connection of the instrument	19
Service information	20
Display functions	21-24
Calibration/adjustment	25
Warranty	25
Ordering data	25
Accessories: Measuring sections	26
EC conformity declaration	27-28
Contact	32

INTRODUCTION

Dear customer,

thousands of customers buy our high standard products every year. There are a few good reasons for doing so:

- The cost-performance ratio - reliable quality at a fair price.
- We have the ideal solutions for your measuring tasks based on our expert experience gained over 20 years.
- Our high quality standard.
- Of course, our instruments carry the CE symbol required by the EU.
- We issue calibration certificates and hold seminars.
- We offer a good after sales service.

Our service guarantees fast help.



Measuring instrument conforms with **DIN EN 61326-1** and **EN 61010-1**



Please read carefully before starting the device!

The consumption sensor VA 400 measures the flow velocity (calorimetric principle) in the middle of the pipe. Please observe mounting instruction and inlet section = 15 x inner diameter and outlet section = 5 x inner diameter.

The final values of the measuring ranges are as follows:

VA 400 standard version 92.7 m/s, please take the flow rates from the tables on pages 10-11

VA 400 max. version 185 m/s, please take the flow rates from the tables on pages 12-13

VA 400 high speed version 224 m/s, please take the flow rates from the tables on pages 14-15

1. VA 400 with display with 4... 20 mA analogue and pulse output

Please enter inner diameter of the pipe!

Values indicated in the display:

Actual value in m³/h, m³/min etc.

Counter in m³ resp. l

as well as pulse output, 1 pulse per m³ resp. l

are calculated according to the set diameter. Please take the analogue value for flow rate 4... 20 mA from the tables on pages 10 to 15.

4 mA always corresponds with the starting value 0 m³/h, 0 m³/min. The final value 20 mA can be taken from the tables on pages 10 to 15.

Example VA 400 Standard:

1" with inner diameter 25.0 mm, 4 mA = 0 m³/h and 20 mA = 122.2 m³/h

2" with inner diameter 53.1 mm, 4 mA = 0 m³/h und 20 mA = 600.0 m³/h

2. VA 400 without Display with 4... 20 mA analogue output (without pulse output)

No adjustments are necessary at the consumption sensor.

The respective final values for the flow rate can be taken from the tables on the pages 10 to 15. 4 mA is always set as scaling value 0. 20 mA is the final value .

Example VA 400 Standard:

1" with inner diameter 25.0 mm, 4 mA = 0 m³/h and 20 mA = 122.2 m³/h

2" with inner diameter 53.1 mm, 4 mA = 0 m³/h und 20 mA = 600.0 m³/h

**Please read carefully before starting the device!****Warning:**

Do not exceed the pressure range of 50. From 10 bar we recommend to use the high-pressure protection for a safe installation and removal.

Observe the measuring ranges of the sensor!

Overheating destroys the sensor.

Observe the admissible storage and transportation temperature as well as the permitted operating temperature (e. g. protect the instrument from direct insolation).

Always observe the direction of flow when positioning the sensor!

The safety ring at the sensor head must always remain undamaged and sit correctly in the destined slot.

The screwed fixture must be pressure tight.

The adapter sleeve must be tightened with a torque of 20 to 30 Nm.

It is absolutely necessary to avoid condensation on the sensor element or water drops in the measuring air as they may cause faulty .

The values of the inlet and outlet sections must not fall below the specified minimum values as this causes increased deviations in the measuring results.

The manufacturer cannot be held liable for any damage which occurs as a result of non-observance or non-compliance with these instructions. Should the device be tampered with in any matter other than a procedure which is described and specified in the manual, the warranty is cancelled and the manufacturer is exempt from liability.

The device is destined exclusively for the described application.

CS Instruments GmbH offers no guarantee for the suitability for any other purpose and is not liable for errors which may have slipped into this operation manual. CS Instruments GmbH is also not liable for consequential damage resulting from the delivery, capability or use of this device.

We offer you to take back the instruments of the instruments family VA 400 which you would like to dispose of.

Adjustments and calibrations should only be carried out by qualified employees from the measurement and control technology branch.

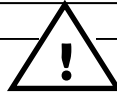
**Please read carefully before starting the device!**

The consumption sensor VA 400 works according to the calorimetric measuring principle.

Burnable gases

If this consumption sensor is used for measurement of burnable gases (e. g. natural gas) we explicitly point out that the sensor has no DVGW (= German Technical Association for Gas and Water) admission, however, it can be used for natural gas. A DVGW admission is not mandatory.

The consumption sensor VA 400 corresponds with the latest state of technology and can generally be used for burnable and non-burnable gases.

For the use in e. g. natural gas the sensor will be calibrated in natural gas. The calibration protocol (inspection certificate) is included in the scope of delivery.

The area outside the pipe (environment of the sensor) is not allowed to be an explosive area.

The installation has to be done by authorized expert staff.

Measured variables:	Volume flow (mass flow), total consumption, velocity
Reference:	DIN 1945, ISO 1217 at 20°C and 1000 mbar (Standard factory setting) - other standards can be adjusted ex factory or by means of the CS Service Software
Principle of measurement:	calorimetric measurement
Sensor:	Pt45, Pt1000
Measuring medium:	Air (Standard factory setting) Nitrogen, argon, CO ₂ , oxygen, nitrous oxide, natural gas
Operating temperature:	-30 ... 110°C probe tube -30 ... 80 °C housing
Operating pressure:	up to 50 bar
Analogue output:	4 ... 20 mA (max. burden < 500 Ohm) Scaling: 0 to maximum flow rate (see tables on pages 10-15) Accuracy: 0.06 mA
Pulse output:	see pages 18 to 19
Power supply:	12 to 30 VDC
Power input:	max. 80 mA at 24 VDC
Accuracy: with meas. section	± 3% m.v. ± 2% m.v. (option via 5 point ISO precision calibration) These data are just valid in connection with a measuring section.
Accuracy: without meas. section	± 4% m.v. ± 3% m.v. (option via 5 point ISO precision calibration) These data are just valid in case of correctly programmed inner diameter
Display:	128 x 64 pixel, with backlight Measured values in maximum 6 digits, Counter max. up to 1,999,999,999, l resp. m ³ drops then back to 0
Units: selectable via software or pushbuttons at the display:	Standard factory settings m ³ /h , m ³ m ³ /h, m ³ /min, l/min, l/s, kg/s, kg/min, kg/h, cfm, m/s
Screw-in thread:	G 1/2"
Material:	Probe tube and screwing: stainless steel 1.4301

VA 400 is a consumption sensor for consumption measurement of compressed air and gases. The version with integrated display indicates the actual consumption e. g. in m^3/h and m^3 .

Special features:

- Option integrated display
 - units freely selectable in the display
 - consumption counter resettable
 - inner pipe diameter adjustable
- Depth scale for accurate installation
- Usable from tube diameter 1/2" (DN 15)
- Easy installation under pressure
- 4...20 mA analogue output for m^3/h resp. m^3/min
- Pulse output for m^3

Programming via Service Software SFA 300.

- Analogue output 4...20 mA scalable
- Switching between m^3/h , m^3/min , ft^3/min , l/min , l/s , cfm , m/s
- Reading out the service data

INSTALLATION DESCRIPTION

Determining the point of installation

In order to maintain the accuracy stipulated in the data sheets, the sensor must be inserted in the centre of a straight pipe section with an undisturbed flow progression.

An undisturbed flow progression is achieved if the sections in front of the sensor (inlet) and behind the sensor (outlet) are sufficiently long, absolutely straight and without any obstructions such as edges, seams, curves etc.

Careful attention must be paid to the design of the outlet section as obstructions can cause counter-flow turbulence as well as turbulence in the direction of the flow.

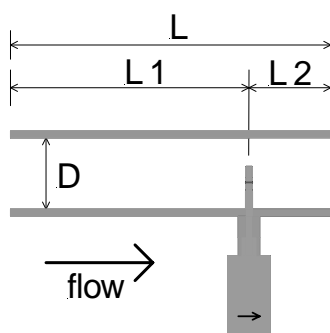

- L = Length of the entire measuring section
- L_1 = Length of inlet section
- L_2 = Length of outlet section
- D = Diameter of measuring section

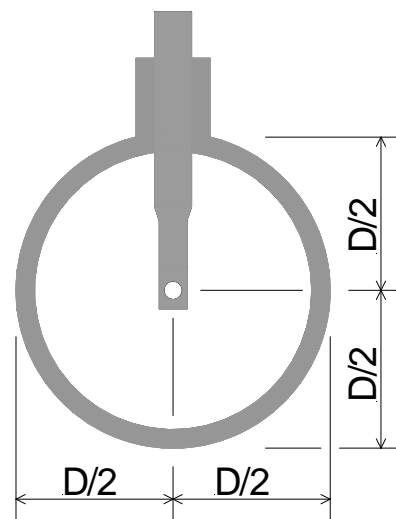

INSTALLATION DESCRIPTION

The following table shows the equalising sections necessary in relation to existing obstructions:

Table of inlet and outlet sections

Flow obstruction in front of the measuring section	Minimum length inlet (L1)	Minimum length outlet (L2)
Slight curve (bend < 90°)	12 x D	5 x D
Reduction (pipe narrows towards the meas. section)	15 x D	5 x D
Expansion (pipe expands towards the meas. section)	15 x D	5 x D
90° bend or T piece	15 x D	5 x D
2 bends á 90° on one level	20 x D	5 x D
2 bends á 90° 3-dimensional change of direction	35 x D	5 x D
Shut-off valve	45 x D	5 x D

The respective minimum values required are indicated here.

If it is not possible to observe the stipulated equalising sections, considerable deviations in measuring results must be expected.

Sensor installation

Consider the flow direction which should match with the arrows at the connector head.



The sensor head must be placed in the centre of the pipe. Therefore the probe shaft has a scale. To determine the right position measure the length from the marked position to the centre of the tube. The probe then will be inserted up to this measure and then tightened up.

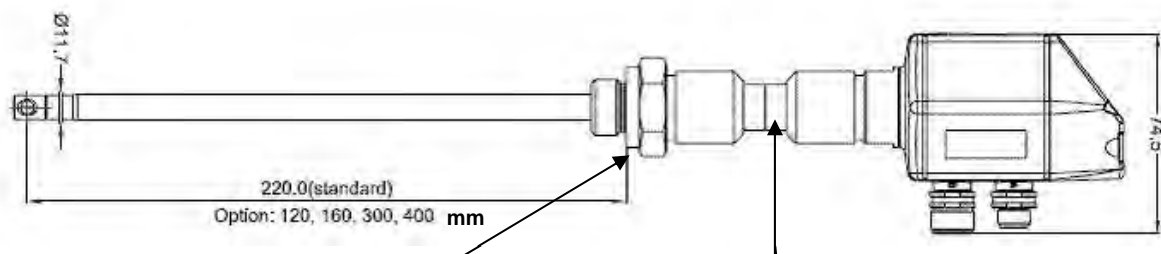

Measure from here to the tube center

Read the insertion position here

Hint for the installation with ball valve:

Ball valve R 1/2", DN 15

Passage ball valve minimum Ø15 mm

Assembly instructions

Safety information must be observed.

Assembly is carried out by inserting the connection thread (1/2" thread, SW 27) into the connection piece. The sensor is then inserted to the required immersion depth and aligned according to the direction of air flow. A depth scale engraved on the probe tube, a flow alignment arrow and an aligning device will be of help to you. Once the sensor has been aligned, the adapter sleeve must be tightened with the stipulated torque (SW 17).

Attention: Alignment of the sensor must not be modified when tightening the connection thread and adapter sleeve. In this case please check the immersion depth and alignment again and correct if necessary. The angular deviation should not be greater than $\pm 2^\circ$ in relation to the ideal position as otherwise the measuring accuracy will decrease.

Commissioning

The valid measuring range and delivery configuration are programmed by the manufacturer on the basis of the user's specifications.

The **stationary** flow and air consumption measuring devices from the VA 400/ DS 300 series function according to the "plug and play" principle. The device is ready for operation as soon as the power supply is connected. .

Measuring ranges depending on the inner diameter of the pipe

The sensor VA 400 - standard version with or without display, has a maximum measuring range of **92.7 m/sec**. The flow rate is programmed to: Inner diameter: **53.1 mm**

This corresponds with an analogue output 4... 20 mA of
 0...600 m³/h 0...10 m³/min 0...10000 l/min 0...166.6 l/sec 0...92.7 m/sec.

In case of the version with display the inner diameter 25.00 has to be set first if the sensor is used in other pipes, e. g. 1", 25 mm.

The analogue output for 1" can be taken from the table below: 4... 20 mA =
 0...122.2 m³/h 0...2.04 m³/min 0...2036.6 l/min 0...33.94 l/sec 0...92.7 m/sec.

In case of the version with display please adjust the respective inner diameter (see page 21).

Inner diameter of the pipe		Flow (final value of measuring range)				max.
Inch	mm	m ³ /h	m ³ /min	l/min	l/s	m/s
1/4"	6.0	4.7	0.08	78.7	1.31	92.7
	10.0	15.1	0.25	251.1	4.19	92.7
	15.0	38.9	0.65	648.6	10.81	92.7
1/2"	16.1	45.6	0.76	760.8	12.68	92.7
3/4"	21.7	89.1	1.48	1484.9	24.75	92.7
	25.0	122.2	2.04	2036.3	33.94	92.7
1"	26.0	132.9	2.21	2214.3	36.90	92.7
	27.3	147.5	2.46	2457.5	40.96	92.7
	28.5	162.0	2.70	2699.6	44.99	92.7
	30.0	180.9	3.01	3014.8	50.25	92.7
	32.8	218.8	3.65	3646.2	60.77	92.7
1 1/4"	36.0	266.3	4.44	4437.6	73.96	92.7
	36.3	270.7	4.51	4511.9	75.20	92.7
	39.3	320.1	5.34	5335.7	88.93	92.7
1 1/2"	40.0	332.5	5.54	5541.4	92.36	92.7
	41.9	366.7	6.11	6111.0	101.8	92.7
	43.1	389.4	6.49	6490.4	108.1	92.7
	45.8	441.9	7.37	7365.7	122.7	92.7
	50.0	530.6	8.84	8844.1	147.4	92.7
2"	51.2	557.1	9.29	9285.1	154.7	92.7
	53.1	600.0	10.00	10000	166.6	92.7
	54.5	632.8	10.55	10546	175.7	92.7
	57.5	707.8	11.80	11797	196.6	92.7
	60.0	773.6	12.89	12892	214.8	92.7
	64.2	888.9	14.81	14814	246.9	92.7

Referred to DIN 1945/ISO 1217 (20 °C, 1000 mbar) and compressed air

Measuring ranges depending from the inner diameter of the pipe

Sonde VA 400 - standard version up to 92.7 m/sec.

Inner diameter of the pipe		Flow (final value of measuring range)				max.
Inch	mm	m ³ /h	m ³ /min	l/min	l/s	m/s
2 1/2"	65.0	913.5	15.22	15224	253.7	92.7
	70.3	1071.1	17.85	17851	297.5	92.7
3"	71.1	1095.6	18.26	18260	304.3	92.7
	76.1	1258.2	20.97	20969	349.4	92.7
	80.0	1390.4	23.17	23173	386.2	92.7
	81.0	1425.4	23.76	23756	395.9	92.7
4"	82.5	1480.5	24.67	24674	411.2	92.7
	84.9	1569.8	26.16	26162	436.0	92.7
	90.0	1766.1	29.44	29435	490.6	92.7
	100.0	2183.1	36.38	36384	606.4	92.7
	107.1	2507.1	41.78	41784	696.4	92.7
	110.0	2644.7	44.08	44077	734.6	92.7
5"	125.0	3423.3	57.1	57055	950.9	92.7
	133.7	3921.1	65.4	65351	1089.2	92.7
6"	150.0	4941.4	82.4	82356	1372.6	92.7
	159.3	5579.8	93.0	92996	1549.9	92.7
	182.5	7323.4	122.1	122055	2034.3	92.7
	190.0	7947.1	132.5	132451	2207.5	92.7
8"	200.0	8816.2	146.9	146936	2448.9	92.7
	206.5	9398.5	156.6	156642	2610.7	92.7
10"	250.0	13775	229.6	229587	3826.5	92.7
	260.4	14945	249.1	249086	4151.4	92.7
12"	300.0	19836	330.6	330606	5510.1	92.7
	309.7	21139	352.3	352331	5872.2	92.7
	339.6	25418	423.6	423646	7060.8	92.7
	388.8	33317	555.3	555291	9254.9	92.7
	500.0	55101	918.4	918350	15305	92.7
	600.0	79345	1322	1322424	22040	92.7
	700.0	107998	1800	1799966	29999	92.7
	800.0	141058	2351	2350976	39182	92.7
	900.0	178527	2975	2975455	49590	92.7
	1000.0	220404	3673	3673401	61223	92.7

Referred to DIN 1945/ISO 1217 (20 °C, 1000 mbar) and compressed air

Measuring ranges depending from the inner diameter of the pipe

The sensor VA 400 - max. version with or without display, has a maximum measuring range of **185.0 m/sec**. The flow rate is programmed to:

Inner diameter: **53.1 mm**

This corresponds with an analogue output 4... 20 mA of
 0...1197.59 m³/h 0...19.96 m³/min 0...19959.88 l/min 0...332.66 l/sec 0...185.0 m/sec.

In case of the version with display the inner diameter 25.00 has to be set first if the sensor is used in other pipes, e. g. 1", 25 mm.

The analogue output for 1" can be taken from the table below: 4... 20 mA =
 0...243.88 m³/h 0... 4.06 m³/min 0...4064.73 l/min 0...67.75 l/sec 0...185.0 m/sec.

In case of the version with display please adjust the respective inner diameter (see page 21).

Inner diameter of the pipe		Flow (final value of measuring range)				max.
Inch	mm	m ³ /h	m ³ /min	l/min	l/s	m/s
1/4"	6.0	9.42	0.16	156.92	2.62	185.0
	10.0	30.08	0.50	501.28	8.35	185.0
	15.0	77.68	1.29	1294.61	21.58	185.0
1/2"	16.1	90.98	1.52	1516.31	25.27	185.0
	21.7	177.84	2.96	2963.94	49.40	185.0
1"	25.0	243.88	4.06	4064.73	67.75	185.0
	26.0	265.20	4.42	4419.99	73.67	185.0
	27.3	294.72	4.91	4912.02	81.87	185.0
	28.5	323.32	5.39	5388.74	89.81	185.0
	30.0	361.08	6.02	6017.98	100.30	185.0
1 1/4"	32.8	436.69	7.28	7278.17	121.30	185.0
	36.0	531.48	8.86	8857.96	147.63	185.0
	36.3	541.06	9.02	9017.70	150.29	185.0
1 1/2"	39.3	639.84	10.66	10664.07	177.73	185.0
	40.0	663.68	11.06	11061.30	184.35	185.0
	41.8	728.41	12.14	12140.14	202.34	185.0
	43.1	777.34	12.96	12955.60	215.93	185.0
	45.8	882.17	14.70	14702.79	245.05	185.0
2"	50.0	1059.23	17.65	17653.79	294.23	185.0
	51.2	1112.05	18.53	18534.19	308.90	185.0
	53.1	1197.59	19.96	19959.88	332.66	185.0
	54.5	1263.13	21.05	21052.15	350.87	185.0
	57.5	1414.66	23.58	23577.72	392.96	185.0
	60.0	1544.12	25.74	25735.30	428.92	185.0
	64.2	1774.33	29.57	29572.14	492.87	185.0

Referred to DIN 1945/ISO 1217 (20 °C, 1000 mbar) and compressed air

Measuring ranges depending from the inner diameter of the pipe

Sensor VA 400 - max. version up to 185.0 m/sec.

Inner diameter of the pipe		Flow (final value of measuring range)				max.
Inch	mm	m ³ /h	m ³ /min	l/min	l/s	m/s
2 1/2"	65.0	1821.03	30.35	30350.57	505.84	185.0
	70.3	2137.86	35.63	35631.08	593.85	185.0
	71.1	2186.80	36.45	36446.65	607.44	185.0
3"	76.1	2511.24	41.85	41853.97	697.57	185.0
	80.0	2778.58	46.31	46309.59	771.83	185.0
	82.5	2958.51	49.31	49308.50	821.81	185.0
	84.9	3133.15	52.22	52219.09	870.32	185.0
4"	90.0	3525.11	58.75	58751.80	979.20	185.0
	100.0	4357.22	72.62	72620.27	1210.34	185.0
	107.1	5003.91	83.40	83398.43	1389.97	185.0
5"	110.0	5278.56	87.98	87976.01	1466.27	185.0
	125.0	6824.50	113.74	113741.61	1895.69	185.0
	133.7	7807.53	130.13	130125.42	2168.76	185.0
6"	150.0	9839.04	163.98	163984.07	2733.07	185.0
	159.3	11096.91	184.95	184948.45	3082.47	185.0
	182.5	14581.94	243.03	243032.33	4050.54	185.0
8"	190.0	15805.08	263.42	263418.04	4390.30	185.0
	200.0	17533.48	292.22	292224.67	4870.41	185.0
	206.5	18691.68	311.53	311527.93	5192.13	185.0
10"	250.0	27428.75	457.15	457145.91	7619.10	185.0
	260.4	29793.76	496.56	496562.71	8276.05	185.0
12"	300.0	39544.48	659.07	659074.72	10984.58	185.0
	309.7	42143.03	702.38	702383.91	11706.40	185.0
	339.6	50673.25	844.55	844554.17	14075.90	185.0
	400.0	70301.30	1171.69	1171688.40	19528.14	185.0
	500.0	109845.79	1830.76	1830763.12	30512.72	185.0
	600.0	158177.93	2636.30	2636298.89	43938.31	185.0
	700.0	215297.74	3588.30	3588295.71	59804.93	185.0
	800.0	281205.22	4686.75	4686753.58	78112.56	185.0
	900.0	355900.35	5931.67	5931672.51	98861.21	185.0
	1000.0	439383.15	7323.05	7323052.48	122050.87	185.0

Referred to DIN 1945/ISO 1217 (20 °C, 1000 mbar) and compressed air

Measuring ranges depending from the inner diameter of the pipe

The sensor VA 400 - high speed version with or without display, has a maximum measuring range of **224.0 m/sec**. The flow rate is programmed to:

Inner diameter: **53.1 mm**

This corresponds with an analogue output 4... 20 mA of
 0... 1450.06 m³/h 0... 24.17 m³/min 0... 24167.64 l/min 0...402.79 l/sec 0... 224.0 m/sec.

In case of the version with display the inner diameter 25.00 has to be set first if the sensor is used in other pipes, e. g. 1", 25 mm.

The analogue output for 1" can be taken from the table below: 4... 20 mA =
 0... 295.30 m³/h 0... 4.92 m³/min 0... 4921.62 l/min 0... 82.03 l/sec 0... 224.0 m/sec.

In case of the version with display please adjust the respective inner diameter (see page 21).

Inner diameter of the pipe		Flow (final value of measuring range)				max.
Inch	mm	m ³ /h	m ³ /min	l/min	l/s	m/s
1/4"	6.0	11.40	0.19	190.00	3.17	224.0
	10.0	36.42	0.61	606.96	10.12	224.0
	15.0	94.05	1.57	1567.53	26.13	224.0
1/2"	16.1	110.16	1.84	1835.96	30.60	224.0
	21.7	215.33	3.59	3588.77	59.81	224.0
1"	25.0	295.30	4.92	4921.62	82.03	224.0
	26.0	321.11	5.35	5351.77	89.20	224.0
	27.3	356.85	5.95	5947.52	99.13	224.0
	28.5	391.48	6.52	6524.74	108.75	224.0
	30.0	437.20	7.29	7286.64	121.44	224.0
	32.8	528.75	8.81	8812.49	146.87	224.0
	36.0	643.52	10.73	10725.32	178.76	224.0
1 1/4"	36.3	655.12	10.92	10918.73	181.98	224.0
	39.3	774.73	12.91	12912.18	215.20	224.0
	40.0	803.59	13.39	13393.14	223.22	224.0
	41.8	881.96	14.70	14699.41	244.99	224.0
	43.1	941.21	15.69	15686.78	261.45	224.0
	45.8	1068.14	17.80	17802.30	296.71	224.0
	50.0	1282.52	21.38	21375.40	356.26	224.0
2"	51.2	1346.48	22.44	22441.40	374.02	224.0
	53.1	1450.06	24.17	24167.64	402.79	224.0
	54.5	1529.41	25.49	25490.17	424.84	224.0
	57.5	1712.89	28.55	28548.16	475.80	224.0
	60.0	1869.63	31.16	31160.58	519.34	224.0
	64.2	2148.38	35.81	35806.27	596.77	224.0

Referred to DIN 1945/ISO 1217 (20 °C, 1000 mbar) and compressed air

Measuring ranges depending from the inner diameter of the pipe

Sensor VA 400 - high speed version up to 224.0 m/sec.

Inner diameter of the pipe		Flow (final value of measuring range)				max.
Inch	mm	m ³ /h	m ³ /min	l/min	l/s	m/s
2 1/2"	65.0	2204.93	36.75	36748.79	612.48	224.0
	70.3	2588.55	43.14	43142.50	719.04	224.0
	71.1	2647.80	44.13	44129.99	735.50	224.0
3"	76.1	3040.63	50.68	50677.24	844.62	224.0
	80.0	3364.33	56.07	56072.15	934.54	224.0
	82.5	3582.20	59.70	59703.26	995.05	224.0
	84.9	3793.65	63.23	63227.43	1053.79	224.0
4"	90.0	4268.24	71.14	71137.32	1185.62	224.0
	100.0	5275.76	87.93	87929.41	1465.49	224.0
	107.1	6058.78	100.98	100979.72	1683.00	224.0
	110.0	6391.34	106.52	106522.31	1775.37	224.0
5"	125.0	8263.17	137.72	137719.57	2295.33	224.0
	133.7	9453.44	157.56	157557.27	2625.95	224.0
6"	150.0	11913.22	198.55	198553.68	3309.23	224.0
	159.3	13436.25	223.94	223937.58	3732.29	224.0
	182.5	17655.97	294.27	294266.18	4904.44	224.0
	190.0	19136.96	318.95	318949.42	5315.82	224.0
8"	200.0	21229.73	353.83	353828.78	5897.15	224.0
	206.5	22632.08	377.20	377201.39	6286.69	224.0
10"	250.0	33211.03	553.52	553517.21	9225.29	224.0
	260.4	36074.61	601.24	601243.50	10020.73	224.0
12"	300.0	47880.89	798.01	798014.80	13300.25	224.0
	309.7	51027.24	850.45	850454.04	14174.23	224.0
	339.6	61355.72	1022.60	1022595.32	17043.26	224.0
	400.0	85121.58	1418.69	1418692.98	23644.88	224.0
	500.0	133002.47	2216.71	2216707.78	36945.13	224.0
	600.0	191523.55	3192.06	3192059.20	53200.99	224.0
	700.0	260684.83	4344.75	4344747.24	72412.45	224.0
800.0	340486.31	5674.77	5674771.91	94579.53	224.0	
900.0	430927.99	7182.13	7182133.20	119702.22	224.0	
1000.0	532009.87	8866.83	8866831.11	147780.52	224.0	

Referred to DIN 1945/ISO 1217 (20 °C, 1000 mbar) and compressed air

MAXIMUM VELOCITY OF THE DIFFERENT GASES

Maximum velocities of VA 400 for different gases and reference standards

		VA 400 Standard	VA 400 Max.	VA 400 HighSpeed
		Max. velocity [m/s]	Max. velocity [m/s]	Max. velocity [m/s]
Reference DIN1945/ ISO 1217: 20°C, 1000 mbar (reference at calibration of the sensors)				
Air		92.7	185.0	224.0
Adjustment to DIN 1343: 0°C, 1013.25 mbar				
Air		85.2	170.1	206.0
Argon	Ar	144.9	289.2	350.2
Carbon dioxide	CO ₂	91.7	183.1	221.6
Nitrogen	N ₂	82.4	164.5	199.2
Oxygen	O ₂	88.4	176.4	213.6
Nitrous oxide	N ₂ O	90.9	181.4	219.7
Natural gas	NG	54.8	109.4	132.5

Please note:

The consumption sensor VA 400 corresponds with the latest state of technology and can generally be used for burnable and non-burnable gases.

If this consumption sensor is used for measurement of burnable gases (e. g. natural gas) we explicitly point out that the sensor has no DVGW admission, however, it can be used for burnable gases. A DVGW admission is not mandatory.

For the use in e. g. natural gas the sensor will be calibrated in natural gas. The calibration protocol (inspection certificate) is included in the scope of delivery.

The area outside the pipe (environment of the sensor) is not allowed to be an explosive area.

DRAWING OF THE INSTRUMENT/INSTRUMENTS DIMENSIONS

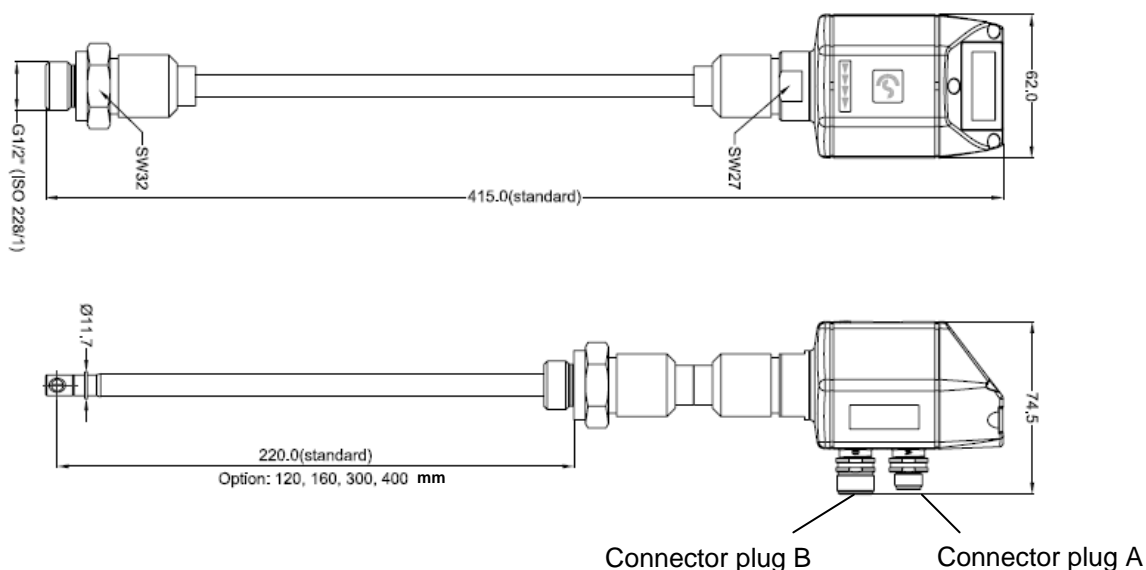

Pulse output:

1 pulse per m³ (factory setting)

With the option display VA 400 or in case of connection to a multifunction measuring instrument DS 300 the pulse output to litre, kg, cf is set via the setting of the consumption unit litre/min, kg/h, cfm.

Active pulse to connector plug A (PIN 5)

In case of the **version VA 400 without display** the pulse is an active signal (not galvanically isolated) Pulse +P = +VB (12...30 VDC), max. current I = 10 mA, to connector plug A.

If VA 400 is connected to a multifunction measuring instrument DS 300 DS 300 will convert the active pulse signal into a galvanically isolated pulse. Pulse diagram please see page 18.

Galvanically isolated pulse to plug B (PIN 4 and PIN 5)

In case of the **version VA 400 with display** there is a galvanically isolated pulse available on connector plug B (PIN 4 and 5) in addition to the connector plug A (PIN 5). An isolated contact is closed for the duration of the pulse (semi-conductor relay galvanically isolated by optocoupler).

Maximum switching capacity: 30 VDC, 20 mA

Pulse diagrams please see page 18.

Pulse output signal indication

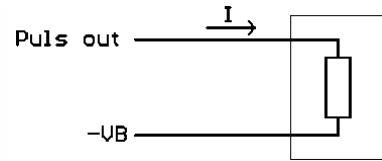
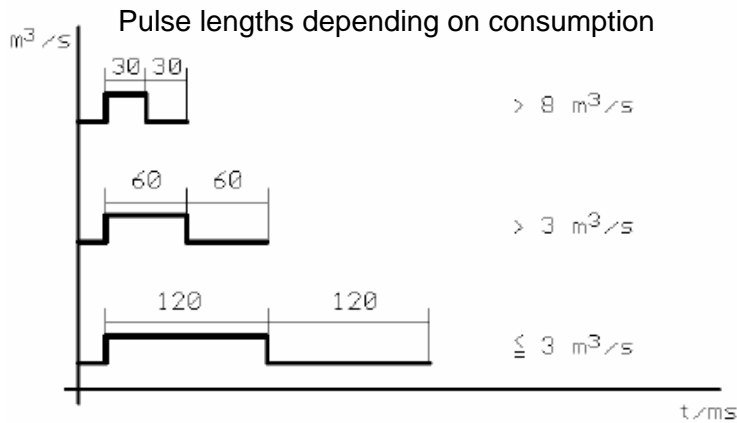

Pulse output:

max. voltage
pulse +P = +VB (12 .. 30 VDC),
active signal
max. current I = 10 mA

Internal pulse receiver:

The numbers of m^3 per second are summed up and indicated after one second.

Pulse lengths depending on consumption

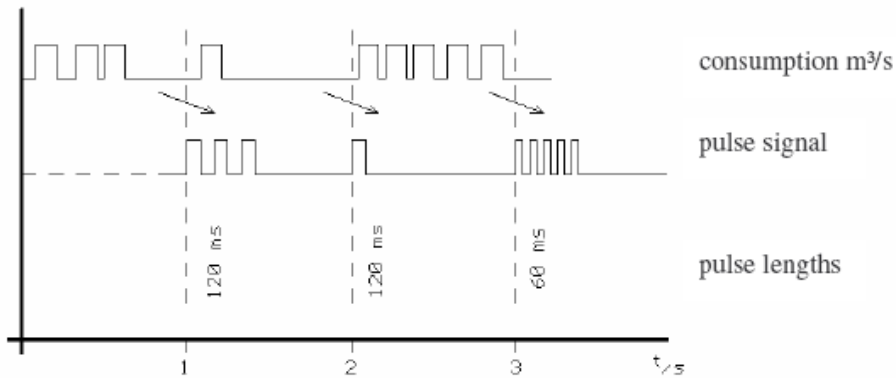

Table of pulse lengths and maximum flow quantities

Pulse length [ms]	[m^3/h]	[m^3/min]	[l/min]	[cfm]	[kg/h]	[kg/min]	[kg/s]
120	10,800	180	180	180	10.800	180	3
60	21,600	360	360	360	21.600	360	6
30	39,600	660	660	660	39.600	660	11
10	129,600	2,160	2,160	2,160	129,600	2,160	36
Max. flow	129,600	2,160	2,160	2,160	129,600	2,160	36

Maximum 36 pulses can be given per second.

**Please observe: If the maximum flow is exceeded there will be no more signals!
In this case please set the units e. g. from l/min to m^3/h .**



CONNECTION OF THE INSTRUMENT

	Pin 1	Pin 2	Pin 3	Pin 4	Pin 5
Connector plug A	NC (SDI)	-VB	+VB	I+ 4..20 mA	NC (pulse) active not isolated
colours connection cables 0553.0104 (5 m) 0553.0105 (10 m)	brown	white	blue	black	grey
Connector plug B only assigned with display	NC	NC	NC	pulse isolated	pulse isolated
colours pulse cables 0553.0106 (5 m) 0553.0107 (10 m)	brown	white	blue	black	grey

Legend:

-VB	Negative supply voltage 0 V
+VB	Positive supply voltage 12...30 VDC - smoothed
I +	Current signal 4..20 mA - actual flow
Plug A PIN 1 (SDI)	is only required for connection to DS 300

Pulse	Pulse for consumption
NC (SDI)	Is not allowed to be put to potential and/or earth. Please cut off cables and isolate them
Plug A PIN 5	only for connection to DS 300



If no connection cable (0553 0104, 0553 0105) is ordered the sensor will be supplied with a M12 connector plug. the user can connect the supply and signal cables as indicated in the connection diagram.



Connector plug A

View reverse side (clamp side)

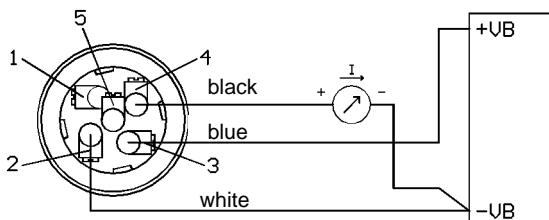

Connector plug B

PIN 4 and 5

(only assigned if VA 400 has a display)

View reverse side (clamp side)

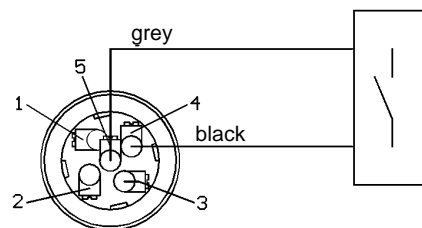

max. 30 VDC, 20 mA

Maintenance

The sensor head should be checked regularly for dirt and cleaned if necessary. Should dirt, dust or oil accumulate on the sensor element, a deviation will occur in the measuring value. An annual check is recommended. Should the compressed air be heavily soiled this interval must be shortened.

Cleaning of the sensor head

The sensor head can be cleaned by carefully moving it to and fro in warm water with a small amount of washing-up liquid. Avoid physical intervention on the sensor (e. g. using a sponge or brush). If soiling cannot be removed, service and maintenance must be carried out by the manufacturer.

Re-calibration

If no customer specifications are given then we recommend to carry out calibration every 12 months. For this purpose the sensor must be sent to the manufacturer.

Spare parts and repair

For reasons of measuring accuracy spare parts are not available. If parts are faulty they must be sent to the supplier for repair.

If the measuring device is used in important company installations we recommend to keep a spare measuring system ready.

Calibration certificates

Calibration certificates are issued by the manufacturer on request. This is a fee-paying service. Precision is tested with DKD (= German calibration authority) certificated volume flow meters.

Display

VA 400 can display up to 3 measured values. This are volumetric flow/mass flow, velocity and total consumption. For better reading only one measured value is displayed. The measured values are toggled during normal operation mode every 3 seconds.

The following changes can be made :

- Diameter
- Unit volume flow (m³/min, m³/h, l/min, l/s, kg/s, kg/min, kg/h, cfm)
- Display of measured value (volume flow, velocity, total consumption)
- Zero consumption
- Display contrast
- Display turnable by 180 °

Settings ex works:

- Volume flow in m³/h
(If the sensor is calibrated for reference DIN 1343, the unit is Nm³/h.
This unit is only adjustable in the factory or with the CS Service Software.)
- Total consumption in m³
- Diameter
If not ordered by customer, the diameter will be preset to 53.1 mm.

On the top of the VA 400 are the capacitive key buttons to operate the display menu.

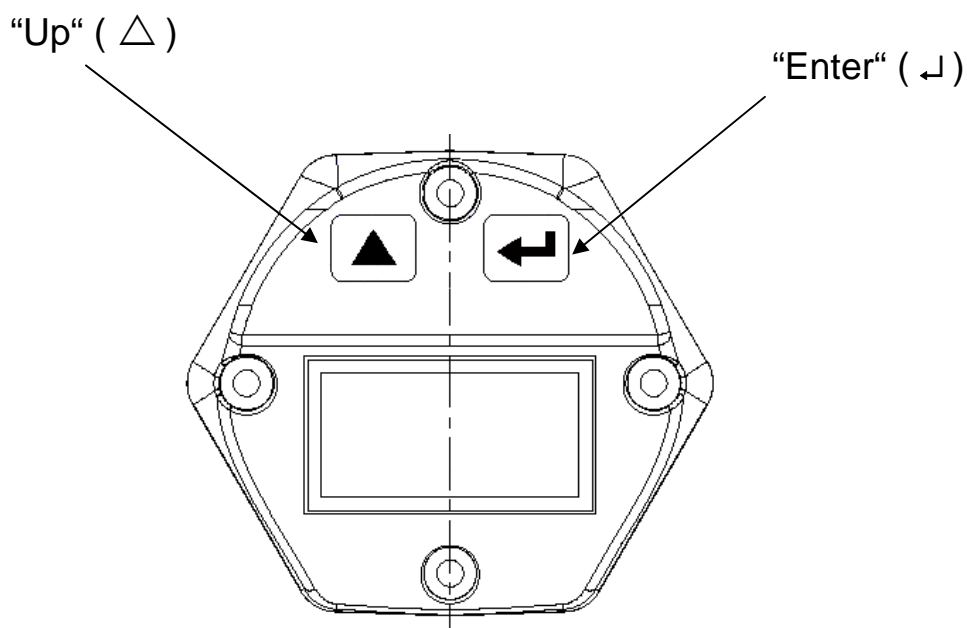

Connection VA 400

After power on, the display will go through an initialisation procedure and will finally show the actual online values.

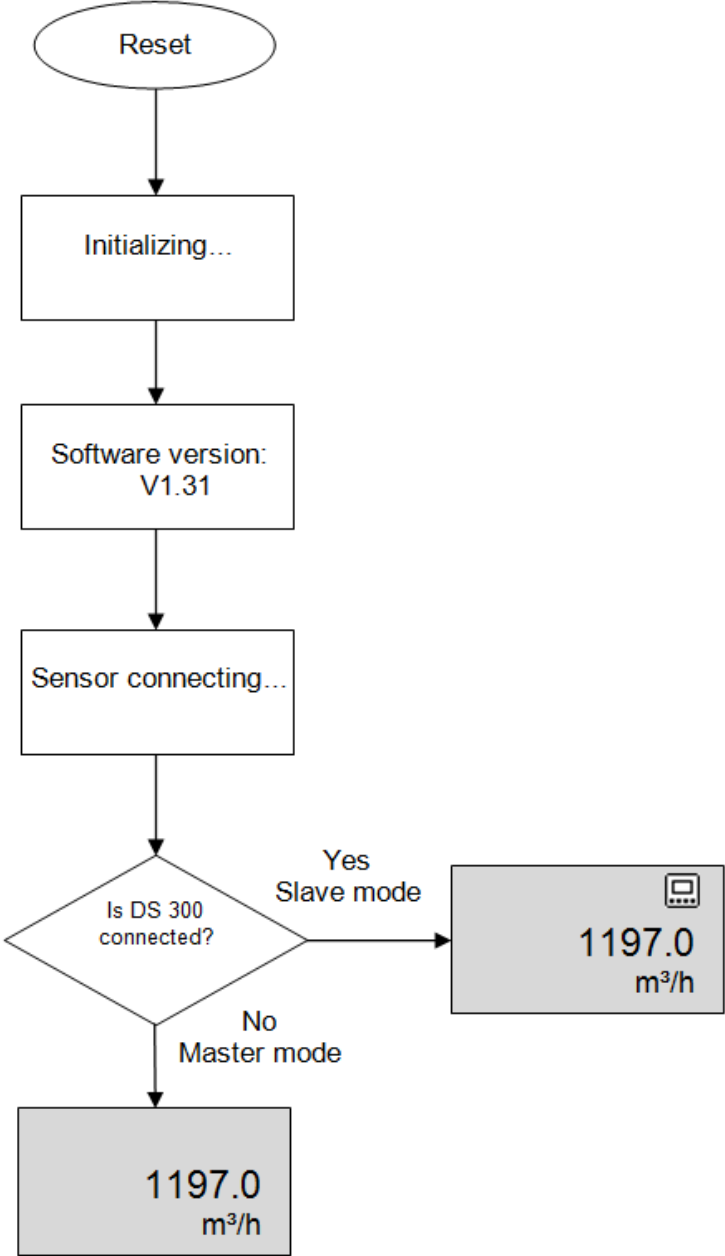

Slave mode

Changing the settings only with DS 300

Master mode

Changing the settings with push buttons VA 400.

Display currently set diameter

A short click on the "Enter"-button shows the currently set diameter.

Input diameter

In order to change the diameter value, keep the "Enter" button pressed for 3 seconds. After input of the unlock code the menu begins with diameter setting. The first digit will start blinking and can be changed with the "Up" key. Every digit has to be confirmed with the "Enter" button.

Configurations-Settings

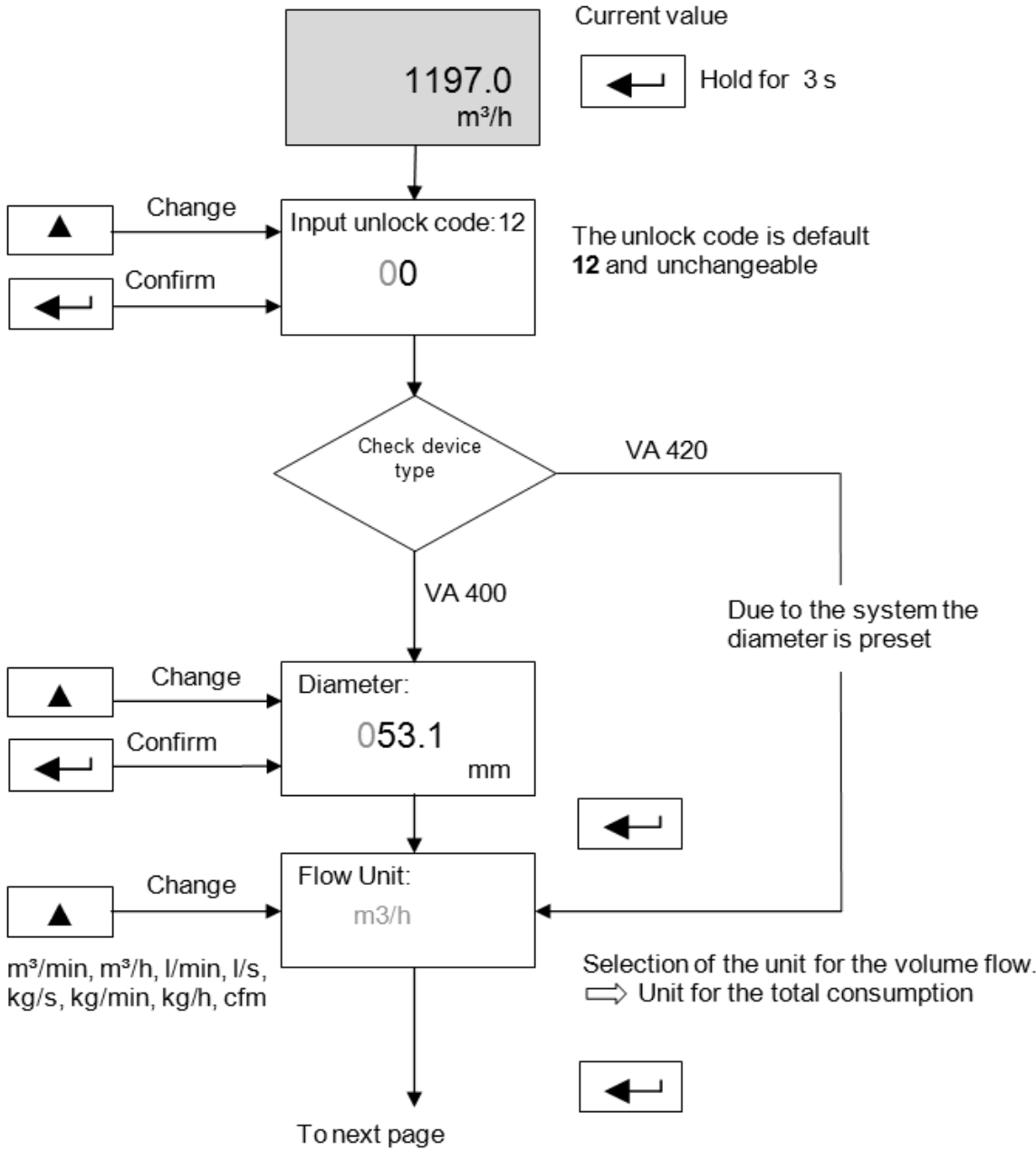

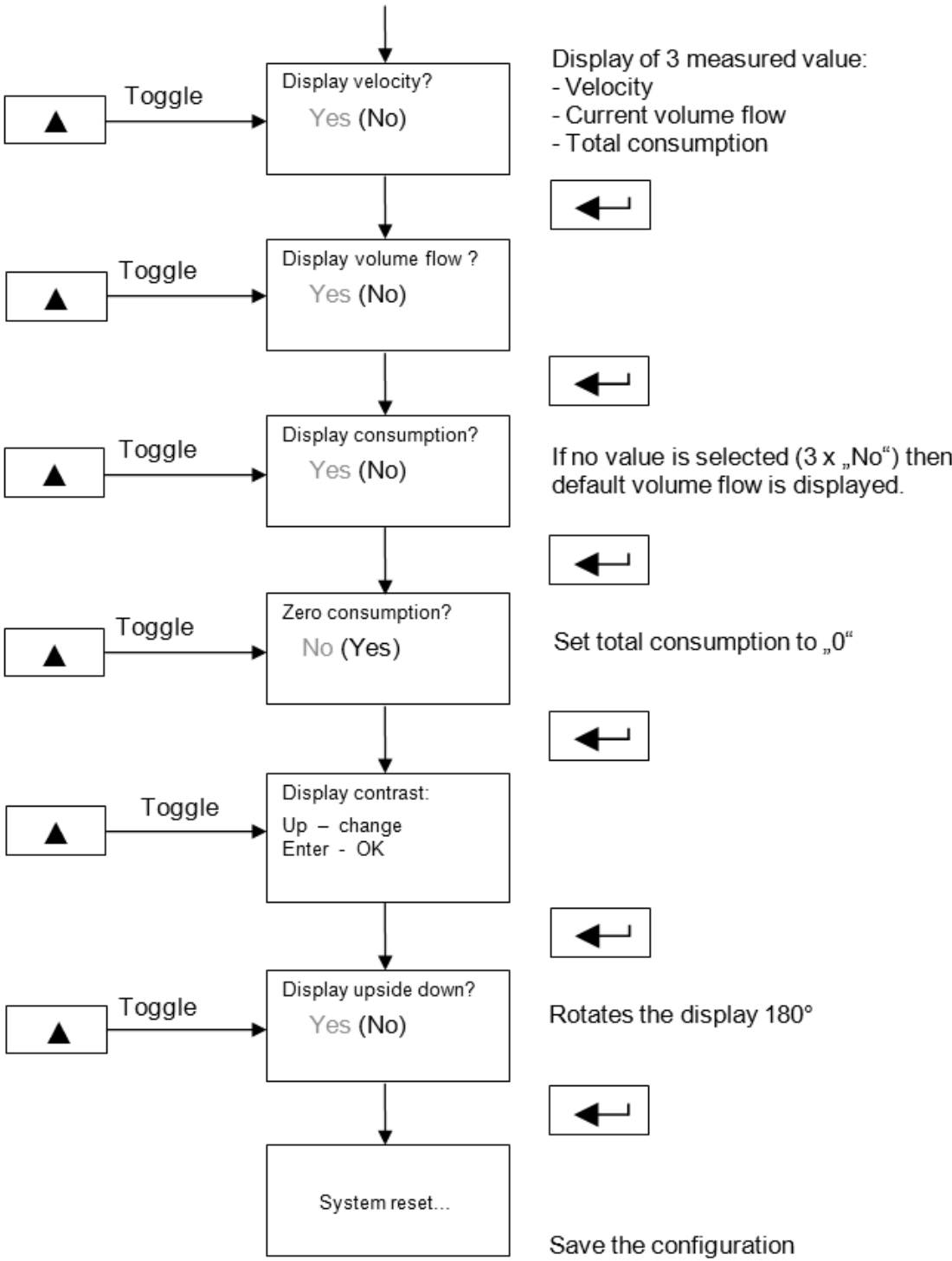

Menu

You can exit the configuration process by pressing and keeping the “Enter” key for 3 sec or no key event for 20 sec. The configuration before this picture will be save and effected late.

According to DIN ISO certification of the measuring instruments we recommend to calibrate and if applicable to adjust the instruments regularly from the manufacturer. The calibration intervals should comply with your internal specification. According to DIN ISO we recommend a calibration interval of one year for the instrument VA 400.

WARRANTY

If you have reason for complaint we will of course repair any faults free of charge if it can be proven that they are manufacturing faults. The fault should be reported immediately after it has been found and within the warranty time guaranteed by us. Excluded from this warranty is damage caused by improper use and non adherence to the instruction manual.

The warranty is also cancelled once the instrument has been opened - as far as this has not been mentioned in the instruction manual for maintenance purposes - or if the serial number in the instrument has been changed, damaged or removed.

The warranty time for the VA 400 is 12 months. If no other definitions are given the accessory parts have a warranty time of 6 months. Warranty services do not extend the warranty time.

If in addition to the warranty service necessary repairs, adjustments or similar are carried out the warranty services are free of charge but there is a charge for other services such as transport and packaging costs. Other claims, especially those for damage occurring outside the instrument, are not included unless responsibility is legally binding.

After sales service after the warranty time has elapsed

We are of course there for you even after the warranty time has elapsed. In case of malfunctions please send us the instrument with a short-form description of the fault. Please do not forget to indicate your telephone number so that we can call you in case of any questions.

ORDERING DATA

<i>Order no.</i>	<i>Description</i>
0695.4001	VA 400 consumption sensor without display including plug
Options:	
Z695.4000	Display
Z695.4003	Max. version 185 m/s
Z695.4002	High speed version 224 m/s
0553.0104	Connection cable for VA/FA Series 400, 5 m with M12 plug
0553.0105	Connection cable for VA/FA Series 400, 10 m with M12 plug
ZSL.0120	Length 120 mm
ZSL.0160	Length 160 mm
ZSL.0220	Length 220 mm
ZSL.0300	Length 300 mm
ZSL.0400	Length 400 mm
0500.3000	DS 300 display for wall mounting

On request CS Instrument will supply the following measuring sections for VA 400 consumption sensors:

Measuring section for VA 400 flow sensors:

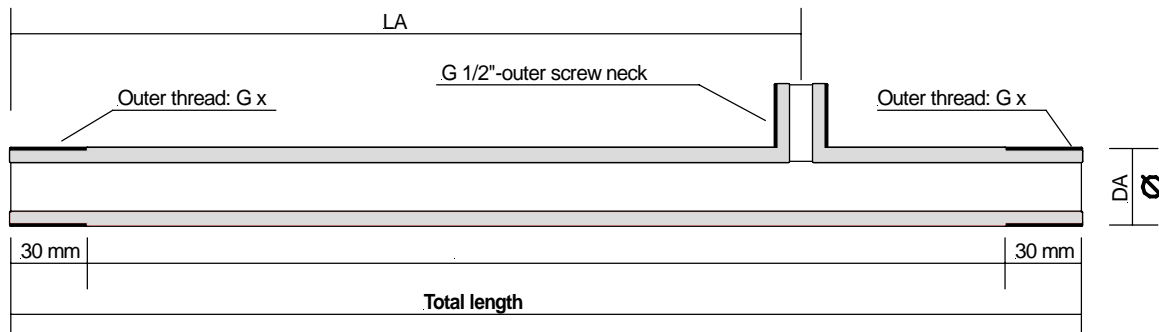

Strömungsrichtung / Direction of air flow →

Outer dia. DA	Length LA	Thread G x	Pipe	Total length
21.3 mm	350 mm	G 1/2"	21.3 * 2.6 mm, Stahl 1.4301	500 mm
26.9 mm	430 mm	G 3/4"	26.9 * 2.6 mm, Stahl 1.4301	600 mm
33.7 mm	530 mm	G 1"	33.7 * 3.2 mm, Stahl 1.4301	750 mm
42.4 mm	660 mm	G 1 1/4"	42.4 * 3.2 mm, Stahl 1.4301	900 mm
48.3 mm	750 mm	G 1 1/2"	48.3 * 3.2 mm, Stahl 1.4301	1000 mm
60.3 mm	930 mm	G 2"	60.3 * 3.6 mm, Stahl 1.4301	1250 mm
76.1 mm	1170 mm	G 2 1/2"	76.1 * 3.6 mm, Stahl 1.4301	1500 mm

Measuring section for VA 400 flow sensors with flange connection:

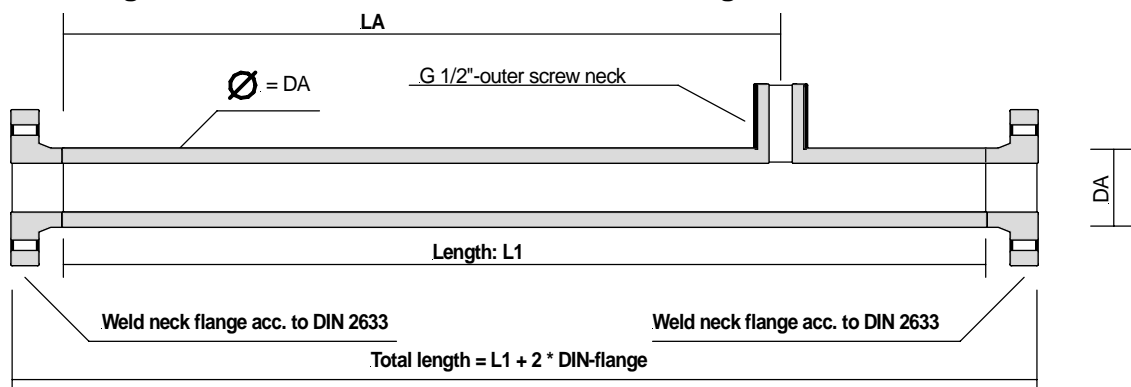

Strömungsrichtung / Direction of air flow →

Outer dia. DA	Length L1	LA	DIN - flange	Pipe	Total length = L1 + 2 * DIN flange
88.9 mm	1750 mm	1330 mm	DN 80 / 88.9	88.9 * 2.0 mm, Stahl 1.4301	1750 + (2*50) = 1850 mm
114.3 mm	2000 mm	1700 mm	DN 100 / 114.3	114.3 * 2.0 mm, Stahl 1.4301	2000 + (2*52) = 2104 mm
139.7 mm	2750 mm	2050 mm	DN 125 / 139.7	139.7 * 3.0 mm, Stahl 1.4301	2750 + (2*55) = 2860 mm
168.3 mm	3000 mm	2450 mm	DN 150 / 168.3	168.3 * 3.0 mm, Stahl 1.4301	3000 + (2*55) = 3110 mm

CS Instruments GmbH

Declaration of Conformity

for

**DIRECTIVE 2002/96/EC OF THE EUROPEAN PARLIAMENT AND OF THE COUNCIL of 27. January 2003
on waste electrical and electronic equipment (WEEE)**

and

**DIRECTIVE 2002/95/EC OF THE EUROPEAN PARLIAMENT AND OF THE COUNCIL of 27. January 2003
on the restriction of the use of certain hazardous substances in electrical and electronic equipment (RoHS)**

of the down mentioned instruments from CS Instruments GmbH:

Pressure dew point meter	series FA 4xx and accessories
Flow and consumption meter	series VA 400/420 and accessories
Pressure dew point meter	DP 300 and accessories
Leak detector	LD 300 and accessories
Multifunction measuring instrument	DS 300 and accessories
Multi-channel display	DS 300 mobile

CS Instruments GmbH as the manufacturer herewith declares that the above instruments and accessories belongs to the category 9 (WEEE 2002/96/EC). Therefore the above instruments do not fall upward aforementioned directive RoHS 2002/95/EC and are not affected by the material restriction.

In accordance with directive WEEE 2002/96/EC the measuring instruments specified above are taken back from CS Instruments GmbH to the disposal.

CS Instruments GmbH Zindelsteiner Str. 15 78052 VS-Tannheim	Tannheim, 24. April 2010
Tel. 07705 978 99-0 Fax 07705 978 99-20	
	Wolfgang Blessing, Geschäftsführer

CS Instruments GmbH

Declaration of Conformity

Consumption counter **VA 400**

CS Instruments GmbH as the manufacturer herewith declares that the above consumption counter complies with the following directives :

Electro-magnetic compliance	2004/108/EG
Low voltage directive	2006/95/EG

For assessing the instrument, the following standards have been referred to:

Electromagnetic compatibility

Emitted interference:	EN 61326-1: 2006-10 + EN 61326-1/Ber.1: 2008-0
Interference resistance:	EN 61326-1: 2006-10 + EN 61326-1/Ber.1: 2008-07

Low voltage directive

Reliability	EN 61010-1: 2002-08 + EN 61010-1/Ber.1:2002-11 + EN 61010-1/Ber.2:2004-01
--------------------	--

Year of first marking with CE label: 07

The product is labeled with the indicated mark



CS Instruments GmbH

Zindelsteiner Str. 15
78052 VS-Tannheim

Phone: +49 (0)7705 978 99-0
Fax: +49 (0)7705 978 99-20

Tannheim, 19. May 2010

Wolfgang Blessing, Managing Director

Sales office SOUTH

Zindelsteiner Str. 15
78052 Villingen-Schwenningen

Phone +49 (0) 7705 97 89 9-0
Fax +49 (0) 7705 97 89 9-20

info@cs-instruments.com
www.cs-instruments.com

Sales office NORTH

Am Oxer 28c
24955 Harrislee

Phone +49 (0) 461 700 20 25
Fax +49 (0) 461 700 20 26

info@cs-instruments.com
www.cs-instruments.com